

S1.1A

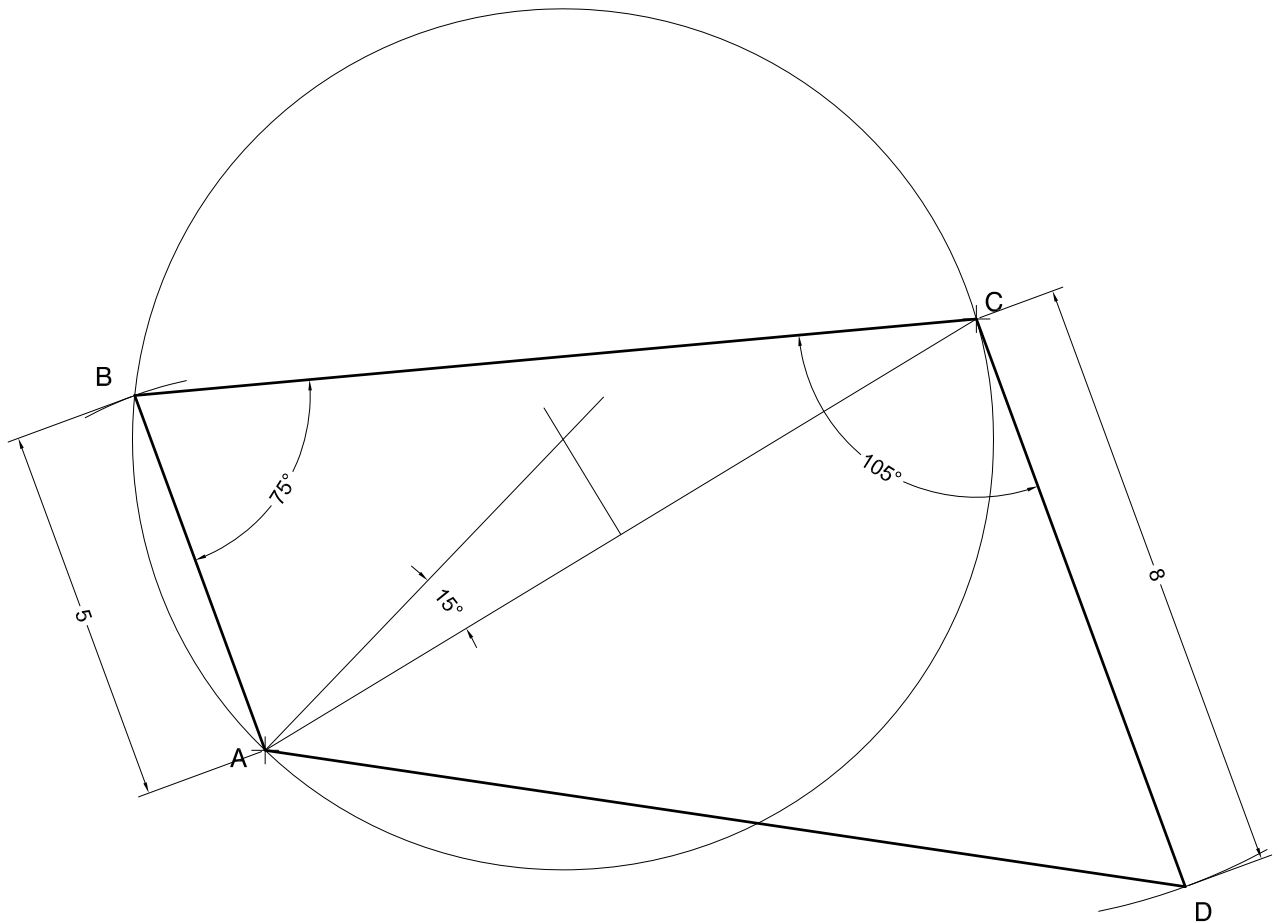
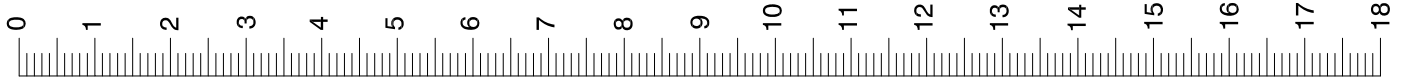

ABC = 75°  
BCD = 105°  
CD = 8  
AB = 5

8,25 metres

S1.1B

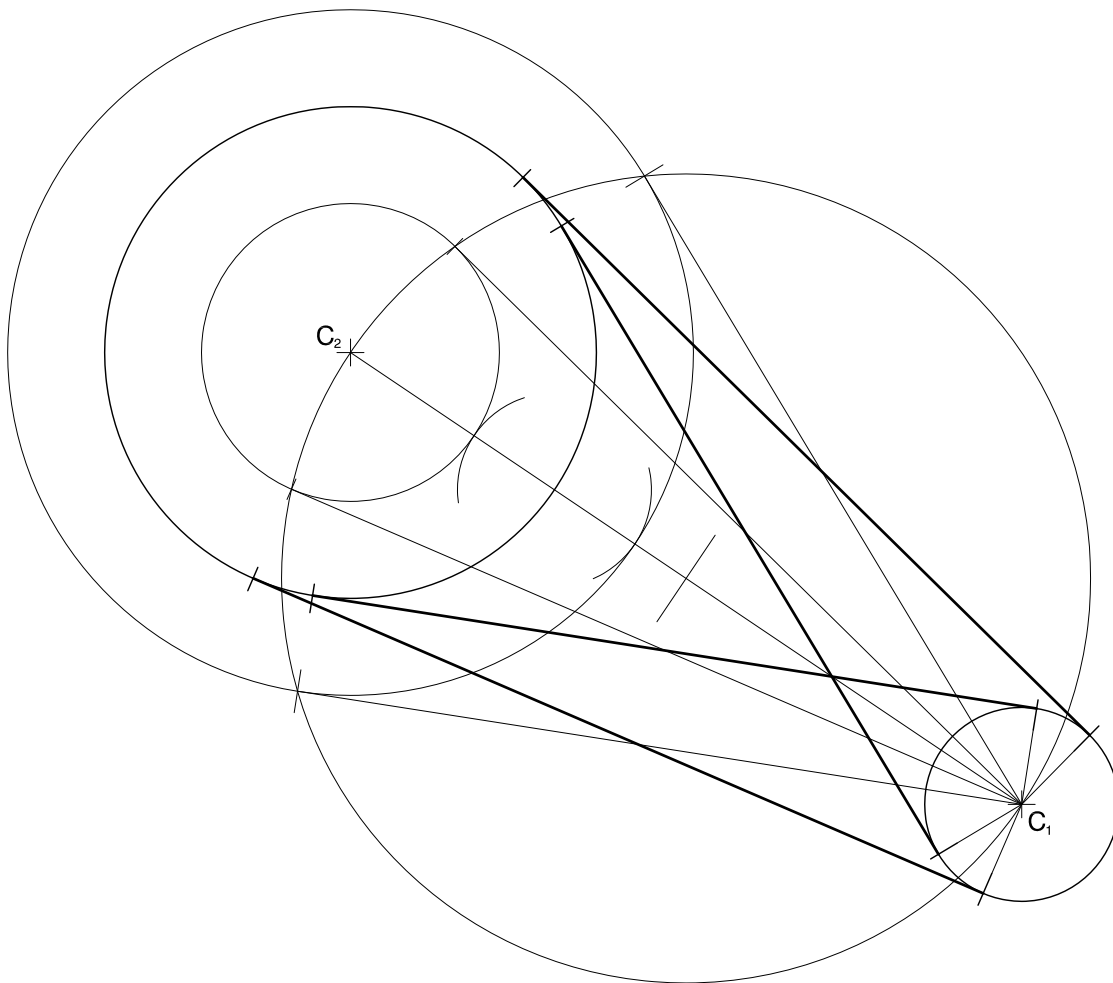
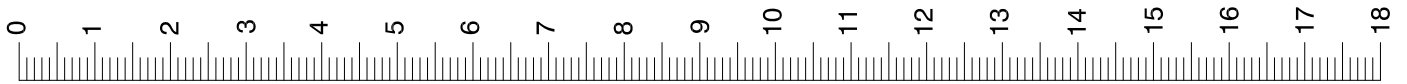

S1.2A

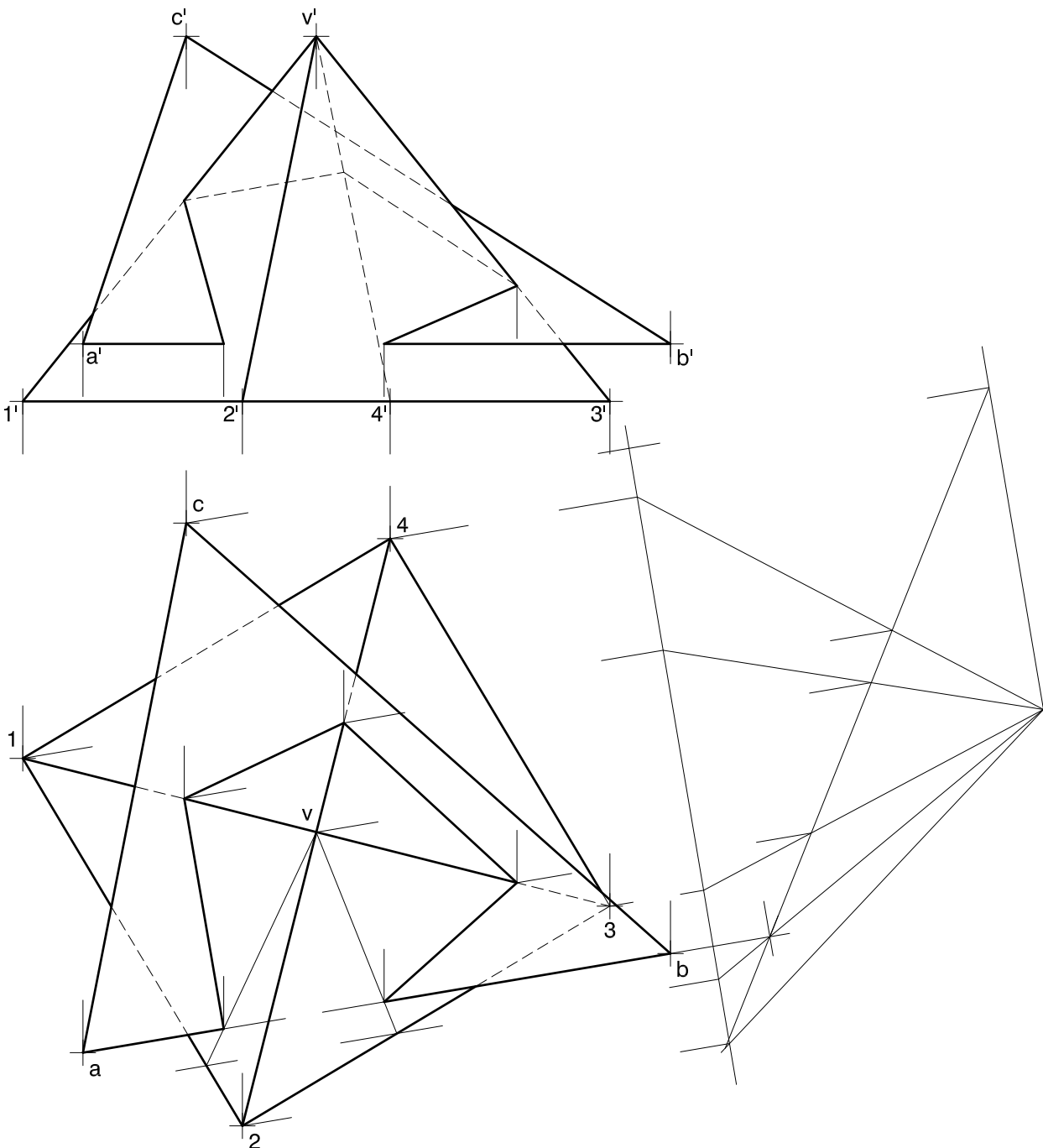

S1.2B

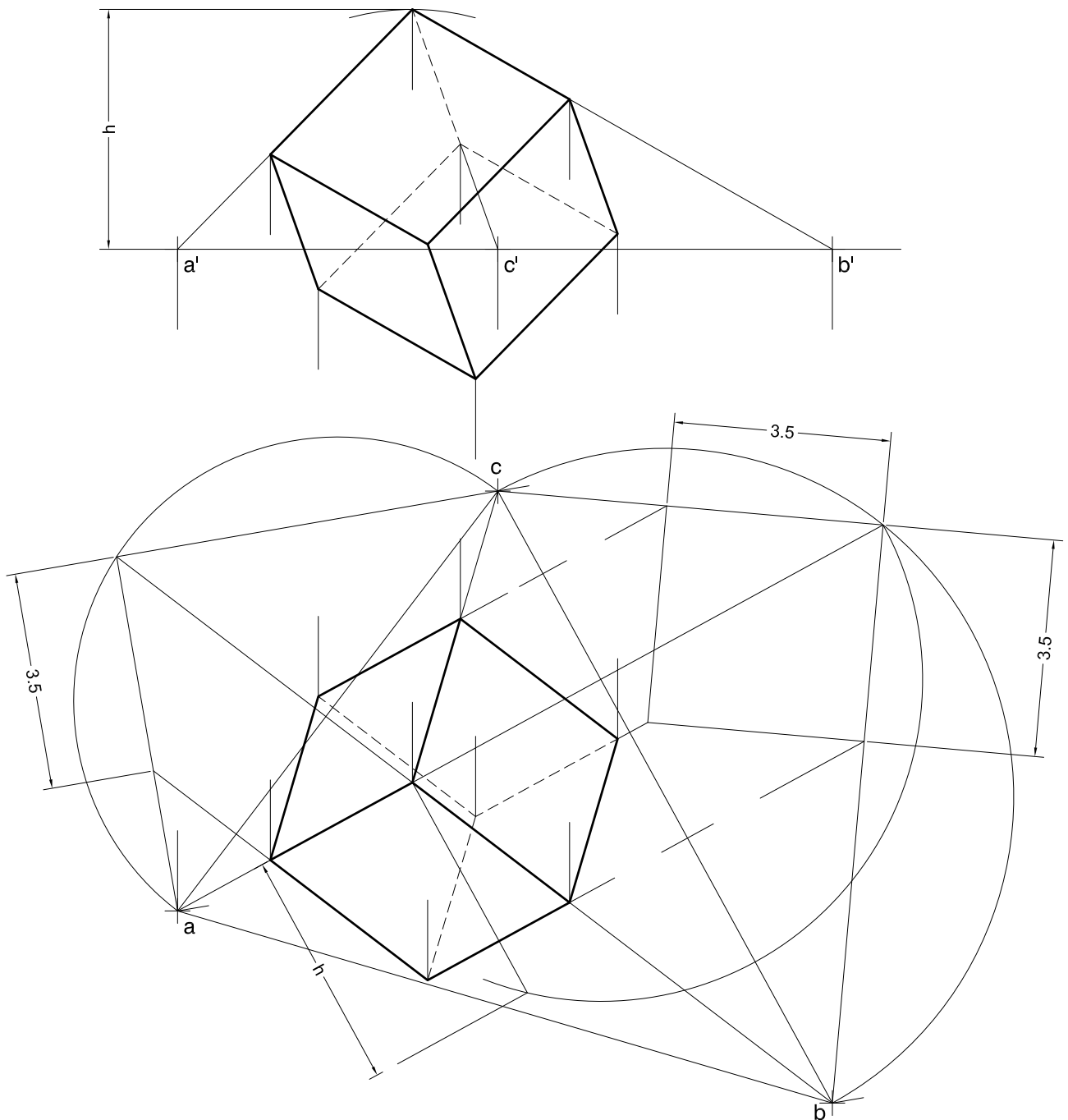
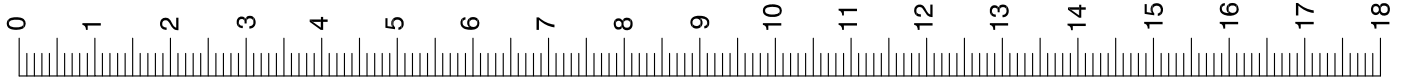

S1.3A

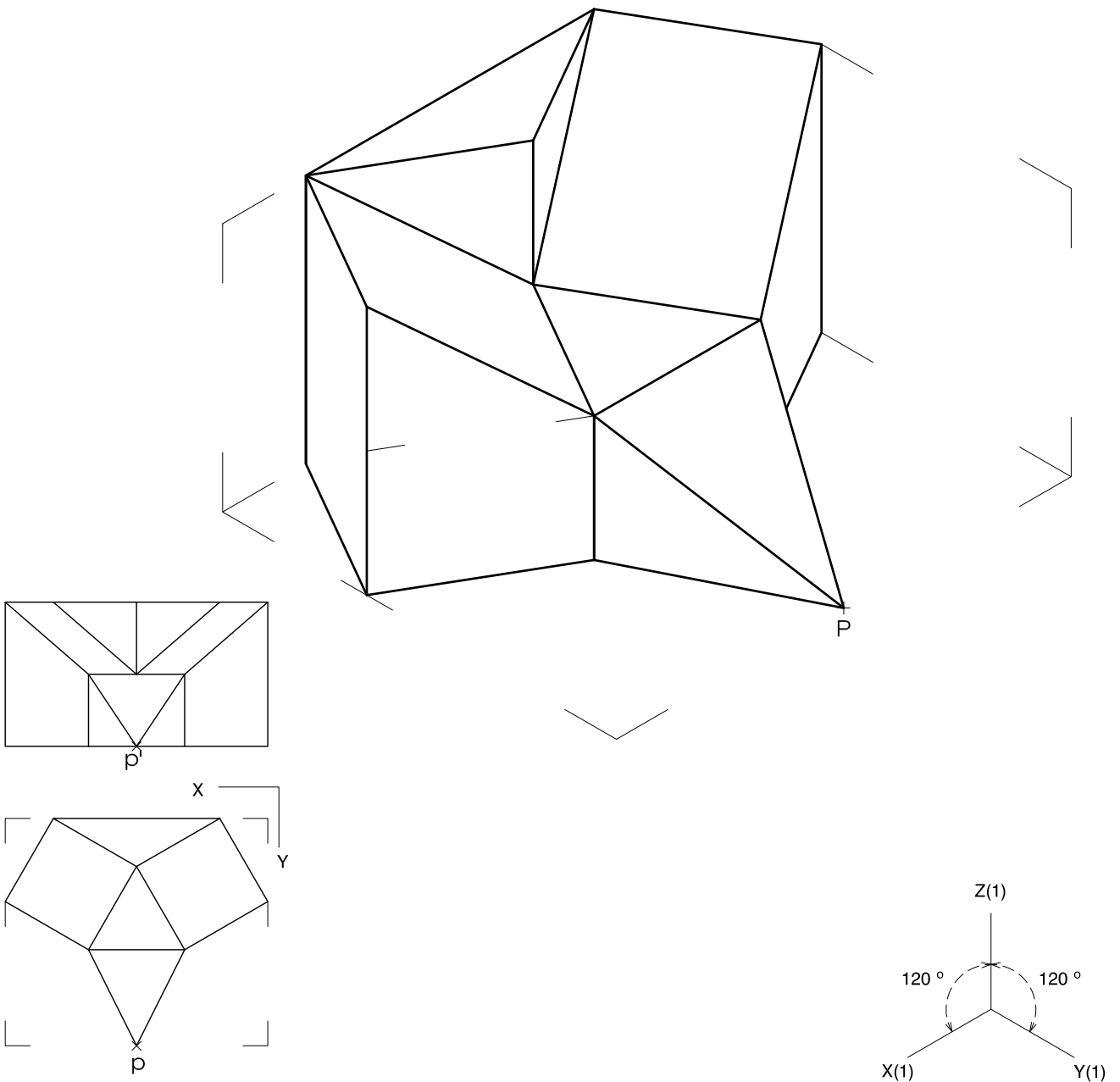
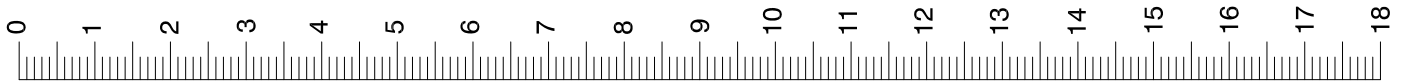

S1.3B

