

S4.1

longituds en metres

- AB = 15
- BC = 22
- CD = 12
- DE = 14
- EA = 17
- AC = 28
- DB = 28

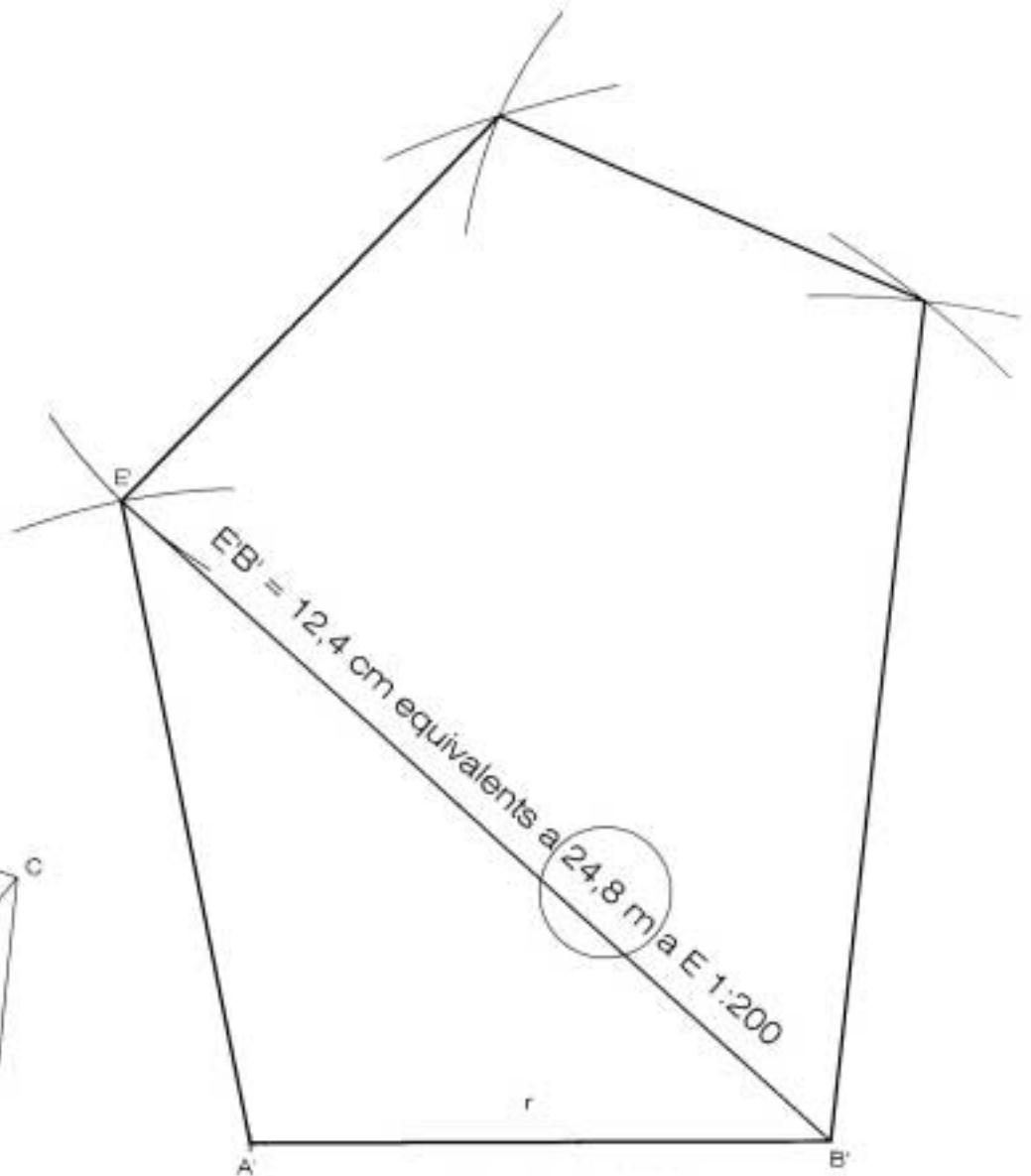
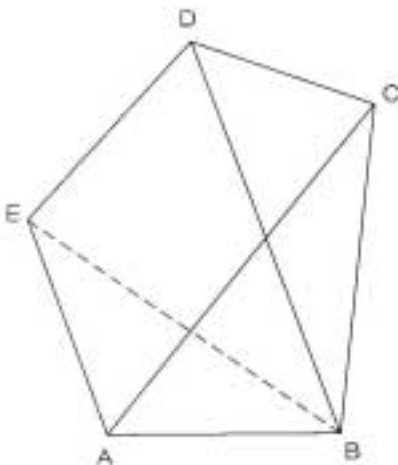

Escala 1 : 200

S4.2

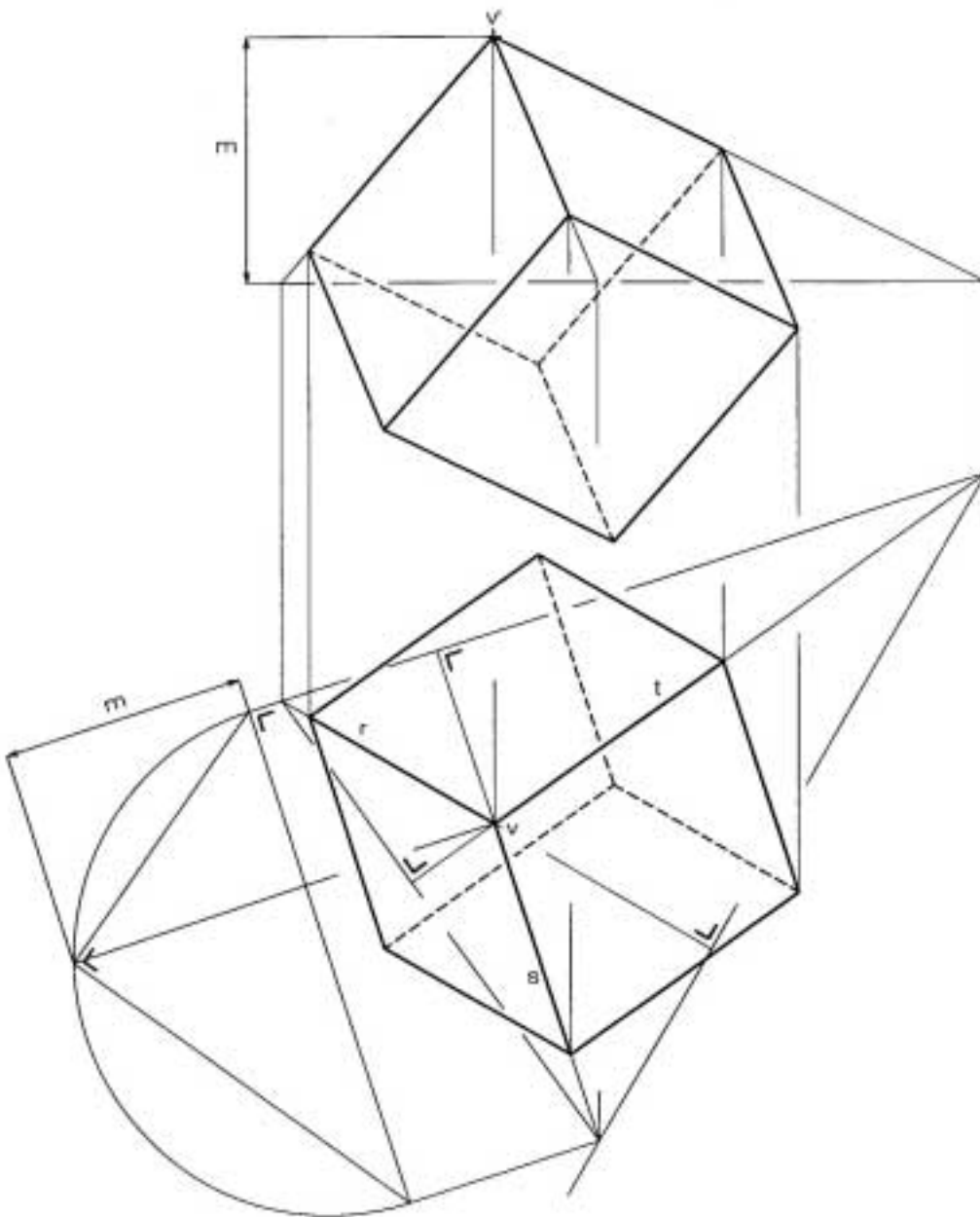

S4.3A

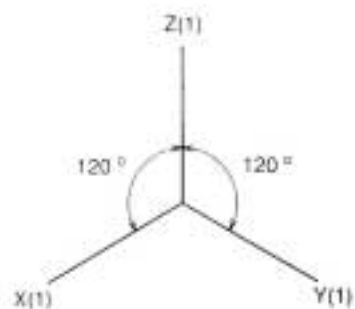
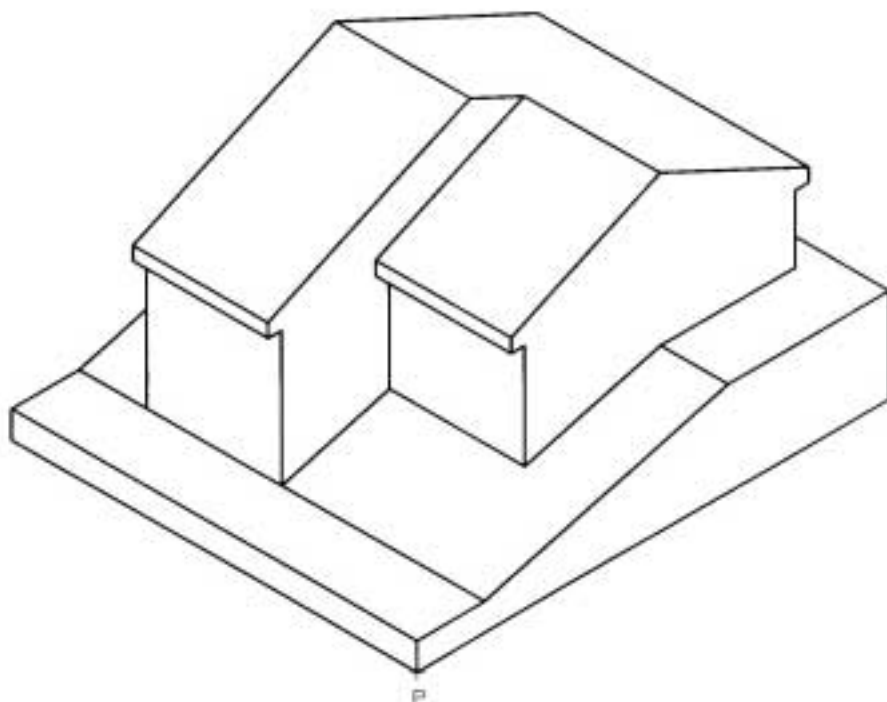
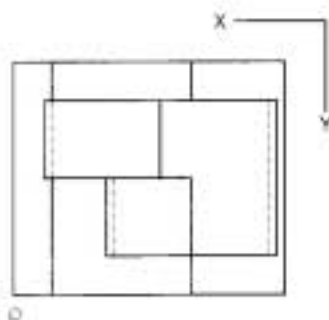
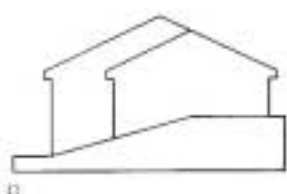

S4.3B

